



OPERATING INSTRUCTIONS EN

ISTRUZIONI D'USO IT

NOTICE D'UTILISATION FR

BEDIENUNGSANLEITUNG DE

INSTRUCCIONES DE USO ES

INSTRUÇÕES DE FUNCIONAMENTO PT

ULISSE **ECO**

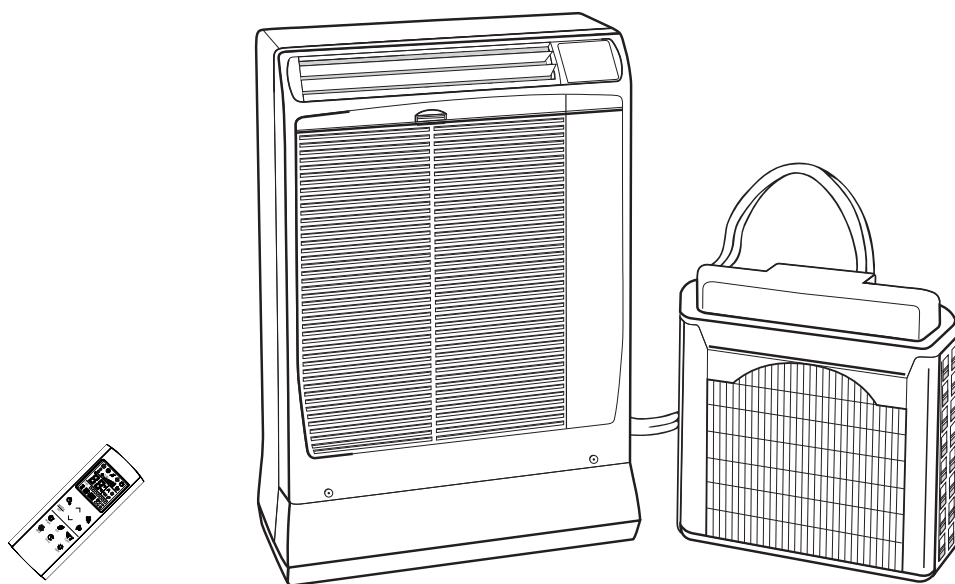

Room air conditioner with remote condenser
Condizionatore d'ambiente con condensatore remoto
Climatiseur avec condenseur a air exterieur - Klimagerät mit außengerät
Acondicionador de ambiente con condensador a distancia
Ar Condicionado com condensador remoto

CONTENTS

EN

SAFETY INSTRUCTIONS	2
INSTALLATION LOCATION.....	3
ELECTRICAL REQUIREMENTS	3
PRODUCT IDENTIFICATION.....	4
MONITOR PANEL	4
AIR CONDITIONER INSTALLATION.....	5
IMPORTANT ADVICE	5
USING THE REMOTE CONTROL UNIT	6
REMOTE CONTROL UNIT	7
HOW TO SET THE CLOCK	8
COOLING/AUTOMATIC MODE.....	8
DEHUMIDIFYING MODE (DRY).....	8
FAN ONLY MODE	8
ADJUSTING THE FAN SPEED	8
NIGHT MODE	9
ENERGY SAVING (ECO).....	9
TURBO MODE.....	9
TIMER SELECTION	9
HOW TO SET SCHEDULES	9
RESET BUTTON.....	9
PARAMETERS SETTING.....	10
ADJUSTING THE AIR FLOW DIRECTION.....	12
OPERATION WITHOUT THE REMOTE CONTROL UNIT.....	12
CARE AND CLEANING.....	12
ACCESSORIES (SUPPLIED ON REQUEST)	13
TIPS FOR ENERGY SAVING	14
TROUBLESHOOTING	14

PRODUCT INFORMATION

The year of production of this unit is indicated in the Nameplate (see figure below).

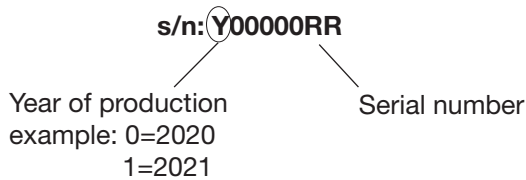

ALERT SYMBOLS

The following symbols used in this manual, alert you to potentially dangerous conditions to users, service personnel or the appliance:



WARNING

This symbol refers to a hazard or unsafe practice which can result in severe personal injury or death.



CAUTION

This symbol refers to a hazard or unsafe practice which can result in personal injury or product or property damage.

SAFETY INSTRUCTIONS



• **Read this booklet carefully before using this air conditioner. If you still have any difficulties or problems, consult your dealer for help.**

- **This air conditioner is designed to give you comfortable room conditions for domestic use. As far as industrial and professional activities are concerned, Argoclima declines all responsibility for any unsuitability of the appliance depending on its characteristics and the purposes it should be responsible for.**



WARNING

- Never use or store gasoline or other flammable vapour or liquid near the air conditioner. It is very dangerous. **Moreover, never install electrical equipment, which is not protected with IPX1 protection (protection against vertical water drop), under the unit.**
- The manufacturer assumes no responsibilities if the safety regulations or local codes are not observed.



CAUTION

- **Never use neither the power main switch or the power plug to start or stop the air conditioner. Always use the ON/OFF button.**
- **Do not stick anything into the air outlet of the air conditioner. This is dangerous because the fan is rotating at high speed.**
- **Do not let children play with the air conditioner.**
- **Do not cool the room too much if babies or invalids are present.**
- **This air conditioner can be used by children aged from 8 years and above and persons with reduced physical, sensory or mental capabilities or lack of experience and knowledge if they have been given supervision or instruction concerning use of the air conditioner in a safe way and understand the hazards involved.**
- **Cleaning and user maintenance shall not be made by children without supervision.**
- **For safety, be sure to turn the air conditioner off and also to disconnect the power before cleaning.**

INSTALLATION LOCATION



WARNING

- Do not install this air conditioner where there are fumes or flammable gases, or in an extremely humid space such as a green house.
- Do not install the air conditioner where excessively high heat-generating objects are placed.
- Do not install the air conditioner where the atmosphere is extremely damp or humid (e.g. greenhouse or laundry) it could be wetted by drops of water (i.e. in laundries).

Avoid:

To protect the air conditioner from heavy corrosion, avoid installing the outdoor unit where salty sea water can splash directly onto it or in sulphurous air near a spa.

- Make sure that there are no obstacles around the indoor unit affecting the free circulation of air. Do not block the air intake and outlet of the unit with curtains or other. Never put objects on the top of the unit.

ELECTRICAL REQUIREMENTS

EN

Before using the appliance

- Check that the power supply at the location where the air conditioner is going to be used is 220/240 volt, single phase.
- For your safety care check periodically the conditions of the electric supply cable; the electrical connection of the unit is Y type with cable prepared in a special way; in case you should notice any damage due to usage, call the nearest After Sale Service to get the cable replaced.
- Before connecting the air conditioner to a power socket, make sure that the socket is provided with an earth connection.
- Verify that the available power supply is sufficient for running other electrical domestic appliances in use simultaneously from the same supply. See the data plate on the unit showing the max. absorbed powers.
- Install a double - pole switch, protected fuses of the delayed type, upstream the electricity wall socket 10A.
- Make sure that circuit breakers, fuses, etc. are of sufficient capacity to handle start - up current (normally for no longer than a second).
- All wiring must conform to the local electrical codes. Consult your dealer or a qualified electrician for details.

WARNING!

The air conditioner is provided with a time-guard system, which does not allow re-starting of compressor until after 3 minutes from a previous stop.

NOTE

This air conditioner is equipped with cooling, drying and fan functions.

Details on these functions are provided here following; refer on these descriptions when using the air conditioner.

OPERATING LIMITS		
COOLING		
MAXIMUM CONDITIONS	OUTDOOR TEMPERATURE	46°C D.B.
	ROOM TEMPERATURE	32°C D.B./23°C W.B.
MINIMUM CONDITIONS	OUTDOOR TEMPERATURE	19°C D.B.
	ROOM TEMPERATURE	19°C D.B./14°C W.B.

PRODUCT IDENTIFICATION

EN

1. Infrared rays remote control unit
2. Monitor panel
3. Supply air deflector
4. Return air grille
5. Outdoor unit
6. Flexible tube
7. Air filter
8. Electric cable with plug
9. Service tube for condensate evacuation
10. Quick coupling cover

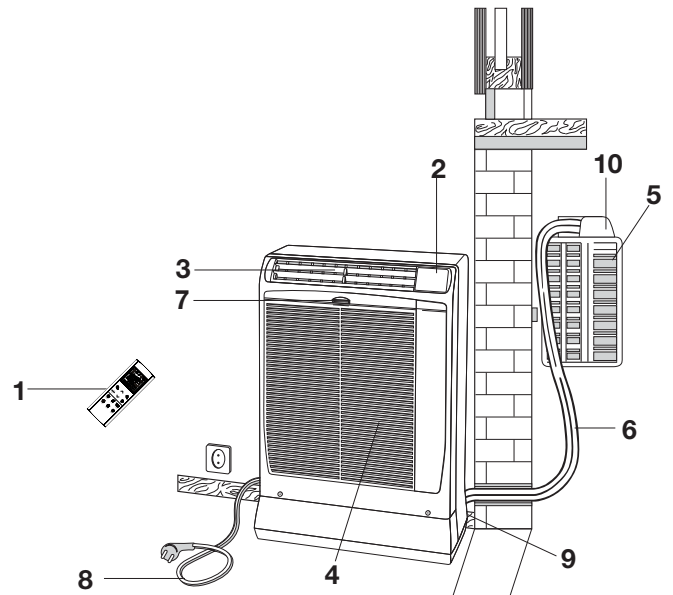

MONITOR PANEL

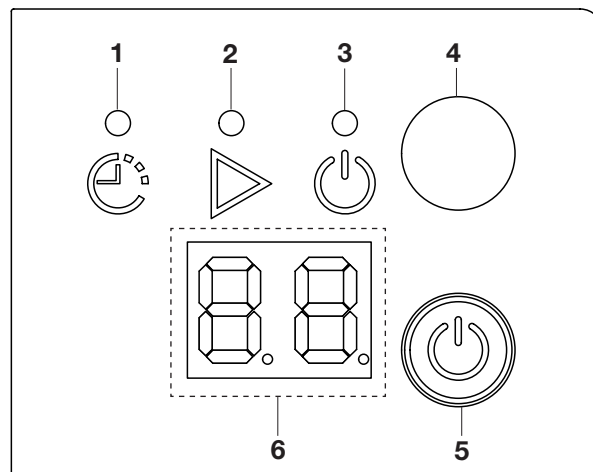

1. **Time setting lamp (TIMER):** This lamp lights up when a timer is activated (see section "TIMER SELECTION").
2. **OPERATION lamp:** This lamp lights up when you switch on the unit.
3. **STANDBY lamp:** this lamp lights up when the air conditioner is connected to the power and ready to receive the remote control command.
4. **Receiver :** it receives signals transmitted from the remote control.
5. **Operation button (without remote control):** Push the button to switch on or off the unit (see section "OPERATION WITHOUT REMOTE CONTROL UNIT"). Press and hold this button for 5 seconds to enable the WiFi configuration (Only for WiFi models, see "WiFi INSTRUCTIONS" manual).

ONLY FOR WiFi MODELS

6. **Display for room temperature and operation errors:** It indicates the room temperature or any operating error codes (see AUTO-DIAGNOSIS table).

Each time a remote control signal is received and stored, the display indicates the set temperature (set point) for a few seconds.



WARNING

The OFF position does not disconnect the power. Use the main power switch to turn off power completely.

The air conditioner is made of two units interconnected by a flexible tube. The indoor unit must be placed in the room to be air conditioned, near a window, a balcony-door or a perimeter wall. The outdoor unit, that provides to the disposal of heat and condensation, must be located outside, on a window sill, on a balcony or hanged to the wall.

POSITIONING OF OUTDOOR UNIT

The outdoor unit must always be kept in vertical position and levelled. Make sure that there are no obstacles around the unit affecting the free circulation of air. A lug at the rear bottom of the unit ensures the minimum distance from the wall (3 cm). The unit must be kept at a minimum distance of cm. 15 (sidewise) and cm. 80 (frontally) from any walls.

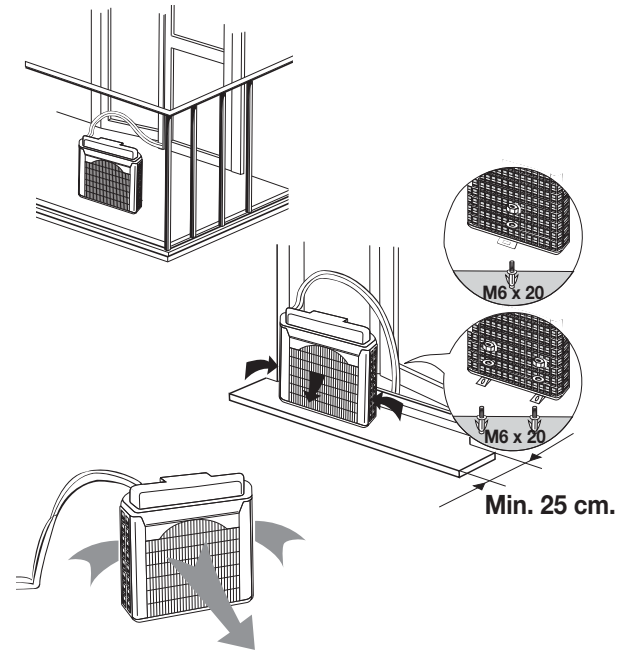

TYPE A

INSTALLATION TYPE A

If your room has a balcony or a window-sill of sufficient depth (min. 25 cm) you may rest the unit freely onto it. For safety's sake, you may anchor the unit to the window-sill using one M6 x 20 expansion bolt in the slot of the lug at the rear bottom of the unit.

The flexible tube may easily pass through the balcony door or window shutters set ajar.

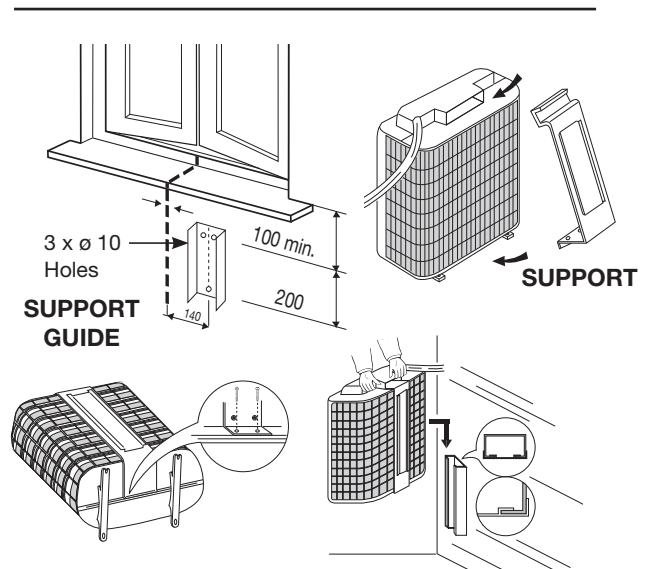

TYPE B

INSTALLATION TYPE B USING THE OUTDOOR UNIT SUPPORT BRACKET KIT (NOT SUPPLIED)

You can buy separately the support bracket kit to fix the outdoor unit to the wall, as follows:

1. Fix the support guide to the wall below the window sill.
2. Insert the support in the handle of outdoor unit, and turn the outdoor unit upside down as shown in the picture.
3. Place the support and secure it at the edge of the unit, using the screws.
4. Insert the support, fixed on the unit, at the guide fixed to the wall. Make sure it is levelled.

IMPORTANT ADVICE

OUTDOOR UNIT

1. When you move the outdoor unit, always hold it by the handle, never pull it by the flexible tube.
2. Never let the outdoor unit hang on the flexible tube.
3. When you recover the outdoor unit after operation, drain away any remaining condensate by tilting the unit.

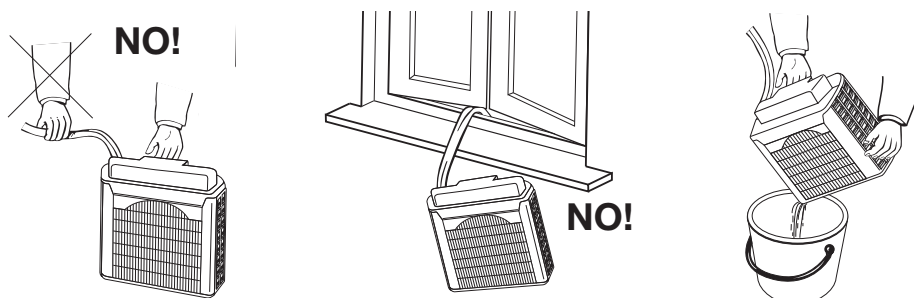

USING THE REMOTE CONTROL UNIT

EN HOW TO INSTALL BATTERIES

- Remove the lid in the rear part of the remote control unit.

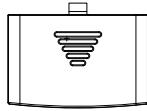
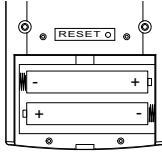



- Insert two AAA alkaline batteries of 1,5 V-DC making sure that point in the direction marked in the battery compartment.
- Set the clock (see procedure on page 8). Remote controller is now ready for operation.
- The batteries last about six months. Depending on how much you use the remote control unit. Remove the batteries if you do not use the remote control unit for more than one month. Replace the batteries when the battery symbol appears on the remote control (☐).
- The batteries of the remote control contain polluted substances. Exhausted batteries must be disposed according to the laws in force.

HOW TO REMOVE BATTERIES

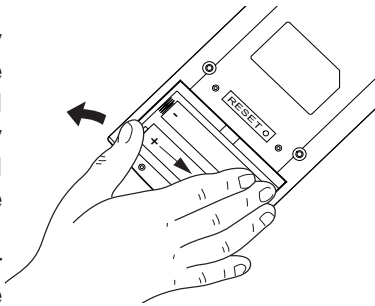
- Remove the lid.
- Press the battery toward the negative end and lift it out by its positive end (as shown in the figure).
- Remove the other battery in the same way.



TEMPERATURE SENSOR SELECTOR

- Under normal conditions the room temperature is detected and checked by the temperature sensor placed in the remote controller (IFEEL  icon displayed). This function is designed to provide a comfortable room temperature by transmitting the temperature control command from the location next to you. When using this function, the remote, control should always be pointed at the air conditioner, therefore it should be placed in a position in which it is visible by the indoor unit (for example, do not put it in a drawer).
- It is possible to disable the remote controller room sensor pressing the FAN/IFEEL  button for a few seconds. In this case the icon on the remote controller display lights off and the sensor placed in the air conditioner becomes active.

NOTE

The remote control unit transmits signals to the indoor unit each time you press a key and at any temperature change detected by the internal sensor. In case of troubles (low batteries, remote control placed in a position not visible by the indoor unit,...) room temperature control is automatically switched to the sensor of the indoor unit. In this case, the temperature around the remote control unit may differ from the temperature detected in the air conditioner position.

OPERATION WITH THE REMOTE CONTROL UNIT

When using the remote control unit, always point the unit transmitter head directly at the air conditioner receiver.

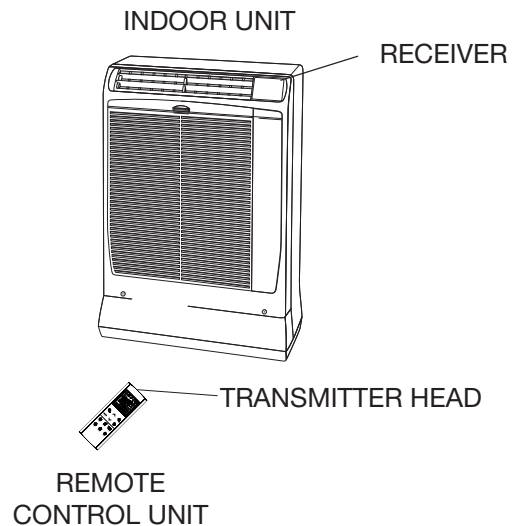

REMOTE CONTROL UNIT

DISPLAY

Information is displayed when the remote controller is switched on.

Operation mode

- Cooling
- Dehumidification
- Fan
- Automatic

Fan speed

Temperature

Days of the week

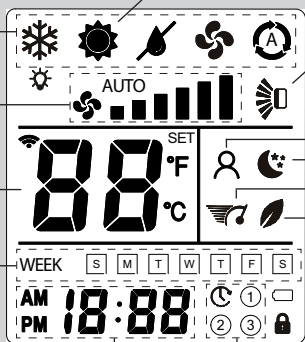

Clock

Timer: 3 types + delayed timer

HEATING MODE: not active on this unit

FLAP: not active on this unit

I FEEL mode is active
(remote controller sensor active)

Night mode

TURBO mode

ECO mode

ON/OFF BUTTON

Press this button to turn the air conditioner ON / OFF.

Press for 2 seconds to lock / unlock the buttons

MODE SELECTOR BUTTON

Press this button to modify the air conditioner mode.

COOLING

The air conditioner makes the room cooler.

HEATING
(not available)

DEHUMIDIFYING (DRY)

The air conditioner reduces the humidity in the room.

FAN

The air conditioner works only as a circulation fan.

AUTOMATIC =

TRANSMITTER

When you press the buttons of the remote control unit, the mark appears on the display to transmit the setting changes to the receiver in the air conditioner.

SENSOR

A temperature sensor inside the remote control unit detects the room temperature. (see on the back of the remote control unit)

FAN/IFEEL BUTTON

Press this button to change the fan speed.

Fan speed is automatically selected by the unit.

Low speed

Medium/low speed

Medium speed

Medium/high speed

High speed

Very high speed

IFEEL MODE

Press this button for a few seconds to modify the active setting for room temperature detection (from remote controller to air conditioner and viceversa).

TEMPERATURE SETTING BUTTONS

- (cooler)

Press this button to decrease the set temperature.

+ (warmer)

Press this button to increase the set temperature.

USE THESE BUTTONS ALSO FOR TIMER SETTING

NIGHT BUTTON

Press this button in order to select the NIGHT mode.

ECO BUTTON

Press this button in order to select the ECO mode.

FILTER BUTTON (INACTIVE BUTTON)

CLOCK AND TIMER SETTING BUTTON

Press this button in order to select the desired timer.

Press for 2 seconds to set the timer
For details refer to paragraphs "HOW TO SET THE PRESENT TIME", "TIMER SELECTION", and "SETTING THE TIMER".

LIGHT BUTTON

Press this button to turn the unit display on or off

FLAP BUTTON (INACTIVE BUTTON)

TURBO BUTTON



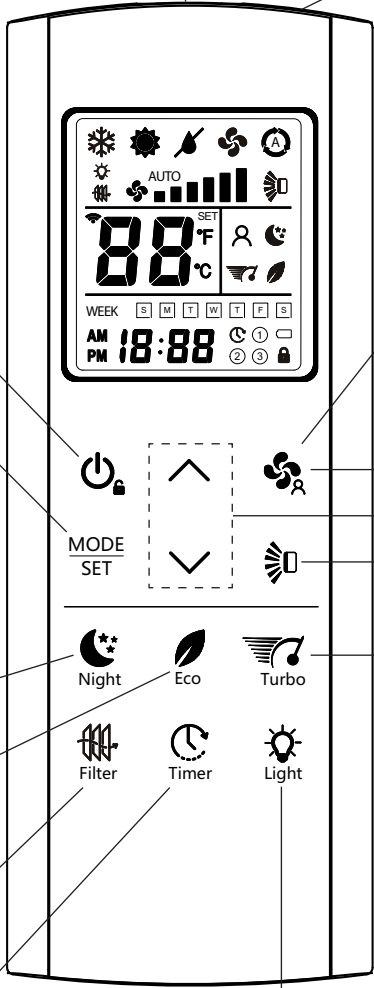

Press this button in order to select the TURBO mode.



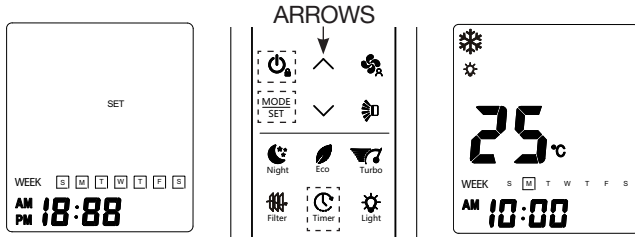



HOW TO SET THE CLOCK

- EN 1. Press for a few seconds the Timer button  .
Press the button  .



2. AM or PM starts flashing: use the arrows to choose AM or PM, then confirm with  .
The hour indication starts flashing: set the hour with the arrows, then confirm with  .
The minutes indication starts flashing: set the minutes with the arrows, then confirm with  .
WEEK starts flashing: set the day of the week with the arrows, then confirm with  .
3. At this point the procedure is finished: press the button  to exit the clock menu.

COOLING / AUTOMATIC MODE

- Turn on the unit with the ON / OFF button.
- Press the button  until the COOLING symbol  appears on the display.
- Press the buttons   to set the desired temperature (the temperature range is between 10 °C and 32 °C).

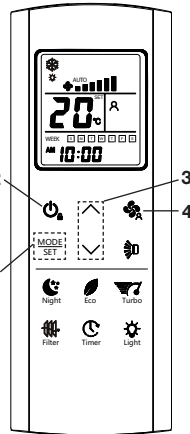

20^{SET}°C THE DISPLAY SHOWS THE SELECTED TEMPERATURE AND THE WORD "SET".

25^{°C} AFTER 5 SECONDS FROM THE REQUIRED TEMPERATURE SETTING THE DISPLAY WILL SHOW THE ROOM TEMPERATURE AGAIN.





4. Press the button  to select the fan speed.

NOTES

If the fan is set in automatic mode and the unit stops because setpoint is reached, also the fan will stop.
If the fan is set in one of the six manual speeds, it will go on operating at the selected speed, even if the unit stops due to reaching the setpoint.

- When the external or internal temperature is too low, the unit could limit the speed of the compressor or switch it off for a certain period of time to avoid the formation of ice on the internal heat exchanger.

DEHUMIDIFYING MODE (DRY)

- Turn on the unit with the ON / OFF button
- Press the button  until the DEHUMIDIFYING symbol  appears on the display
- Press the buttons   to set the desired temperature (the temperature range is between 10 °C and 32 °C).



20^{SET}°C THE DISPLAY SHOWS THE SELECTED TEMPERATURE AND THE WORD "SET".

25^{°C} AFTER 5 SECONDS FROM THE REQUIRED TEMPERATURE SETTING THE DISPLAY WILL SHOW THE ROOM TEMPERATURE AGAIN.

NOTES



- Use DRY operation when you want to reduce the humidity in the room.
- Once the room temperature reaches the set level, the unit repeats the cycle of turning on / off automatically.
- During DRY operation, the fan speed is automatically set (Remote control lamp  is ON) to maximize dehumidification.
- Dry operation is not possible if the indoor temperature is less than 10 °C.

FAN ONLY MODE

If you want to make air circulate without any temperature control, press the button  until the FAN symbol  appears on the display

ADJUSTING THE FAN SPEED

AUTOMATIC

Set with the button  the "AUTO" position  . The unit automatically controls the fan speed. When the air conditioner starts operating, the fan speed varies according to the thermal load of the room .

NOTE

In FAN ONLY mode, the AUTOMATIC speed corresponds to the high speed H.

MANUALE

If you want to manually adjust the fan speed just set the button  as desired:

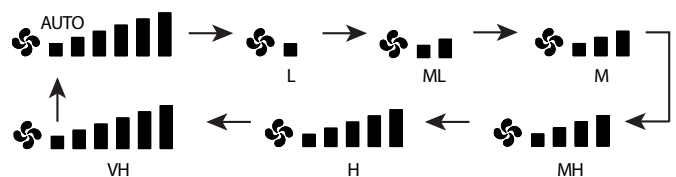



L	Low	MH	Medium-high
ML	Medium-low	H	High
M	Medium	VH	Very high

NIGHT MODE

This program is used to increase silence and comfort during the night.

To activate the Night mode:

1. Press the button  to set the air conditioner in cooling or dehumidification.
2. Press the button .
3. The symbol  appears on the display. Press the button again to release the function.

What does the NIGHT mode mean?

When you select the NIGHT mode, the air conditioner will modify automatically the set temperature after 60 minutes: it will be raised by 1°C.

This enables you to save energy without sacrificing your comfort.

NOTE



During the NIGHT mode the internal fan speed is automatically lowered, reducing the noise.

ENERGY SAVING MODE (ECO)

This program is used to limit the maximum electrical power absorbed by the unit.

When the energy saving program is selected, the air conditioner limits the absorbed power to 75% of the maximum power. This limit can be set by modifying parameter P12 on the remote control (see paragraph "Parameters setting").



To activate the Energy save mode:

1. Press the button  to set the air conditioner in cooling or dehumidification.
2. Press the button .
3. The symbol  appears on the display. Press the button again to release the function.



TURBO MODE



This program is used to increase the maximum power that can be supplied by the air conditioner, even if it involves less silence.

To activate the Turbo mode:

1. Press the button  to set the air conditioner in cooling.
2. Press the button .
3. The symbol  appears on the display. Press the button again to release the function.

TIMER SELECTION

To select the timer, press the button  to switch on the remote control, then press the button  to choose the desired schedule:

-  → ①
or "OFF"
-  → ③







NOTE

In the event of a power failure and restoration, the timer selection must be performed again.

HOW TO SET SCHEDULES

A) DELAYED TIMER

This timer is used to start the unit (if it is off) or to stop the unit (if it is on) after a certain time, to set the delayed time.

1. Press the Timer  button for a few seconds.
2. Press the arrow "up"  to select the delayed timer .
3. Press the button : the hour indication starts flashing; set the hour with the arrows.
4. Press the button  again: the minutes indication starts flashing; set the minutes with the arrows.
5. Confirm with the button , then press the button  to exit the delayed timer menu.





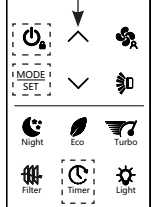







ARROWS



B) SCHEDULE

This timer is used to turn the unit on and off at predefined times and days.

1. Press the Timer  button for a few seconds.
2. Press the arrow "up"  to select the schedule to be set (①, ② or ③).
3. Press the button : ON indication starts flashing.
4. Press the button  again: AM indication starts flashing (you can choose AM or PM with the arrows).
5. Press the button : the hour indication starts flashing; set the desired hour with the arrows.
6. Press the button  again: the minutes indication starts flashing; set the minutes with the arrows.
7. Press the button : OFF indication starts flashing.
8. Repeat the same procedure to set AM or PM, hour and minutes.
9. At this point, press the "up"  arrow and WEEK will start flashing.
9. Press the button : the indication of the first day of the week starts flashing; set ON or OFF with the arrows, then confirm with the button .
9. The indication of the second day of the week starts flashing: repeat the procedure with every day of the week, if desired.
10. At the end press  to exit the menu.



ARROWS

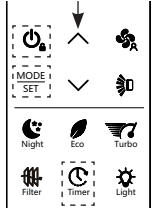

NOTE

- It is possible to set up to 3 weekly schedules at different times using the timers.

RESET BUTTON

Press the RESET button on the back of the remote control if you want to reset all settings and return to the factory setting.



PARAMETERS SETTING

EN

To access to the "Parameter menu", long press "MODE/SET" from the main screen or from the OFF screen:

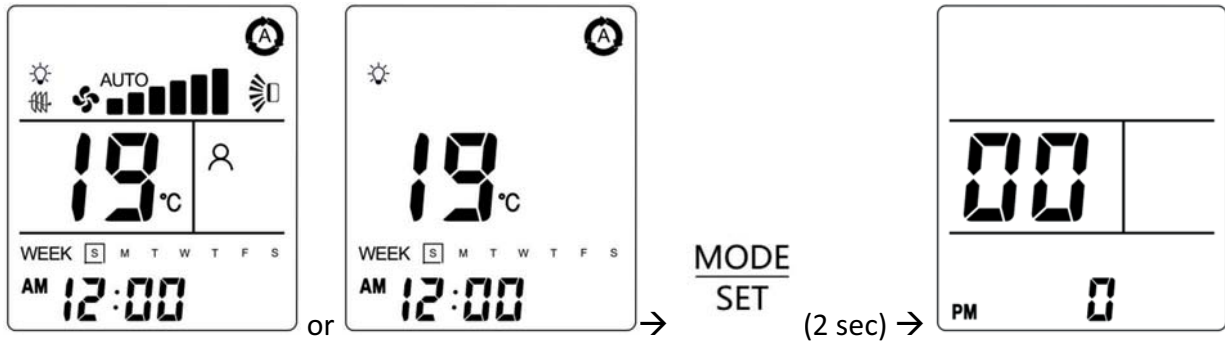

The first parameter shown is P00. Press "UP" or "DOWN" to scroll the parameter list:

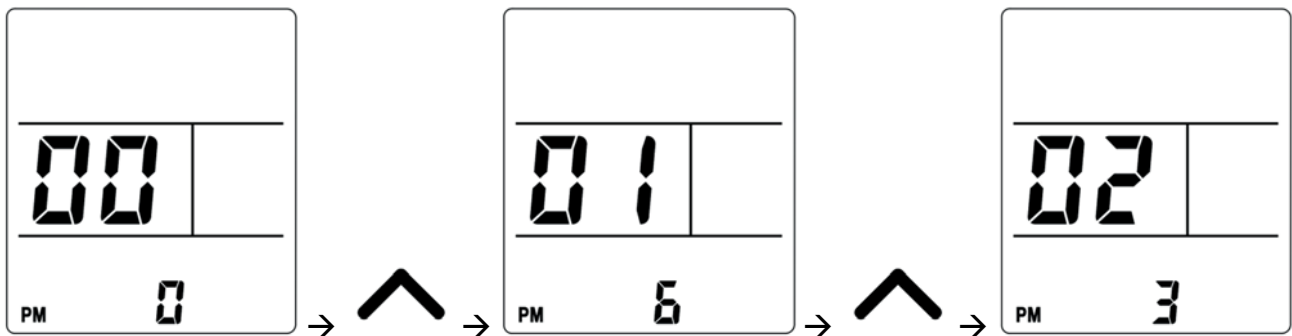

When a parameter has been selected, long press "MODE/SET" to modify the value of the parameter. The value of the parameter starts blinking and SET symbol switches on:

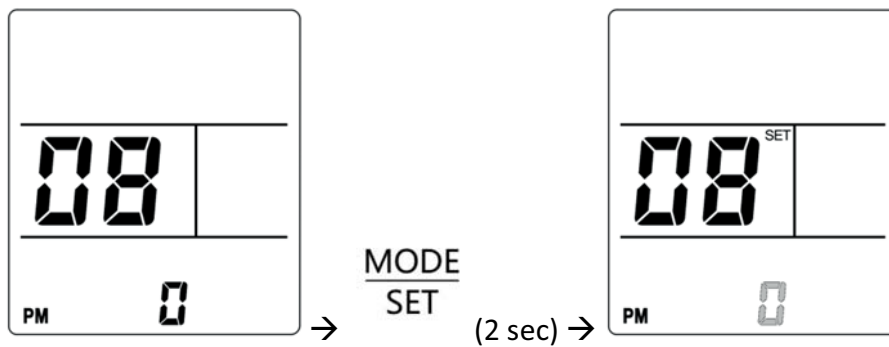

Press "UP" or "DOWN" to modify the value of the parameter, then press "MODE/SET" to save and transmit the selected value of the parameter or press "ON/OFF" to restore the previous value of the parameter:

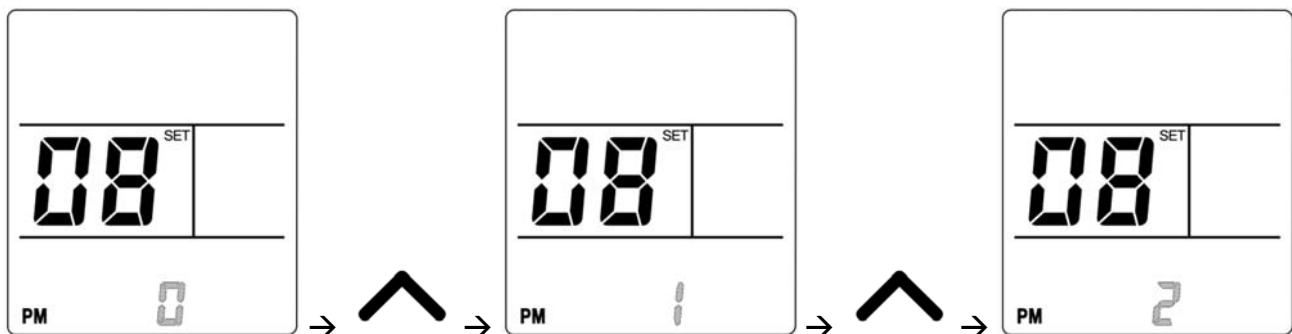

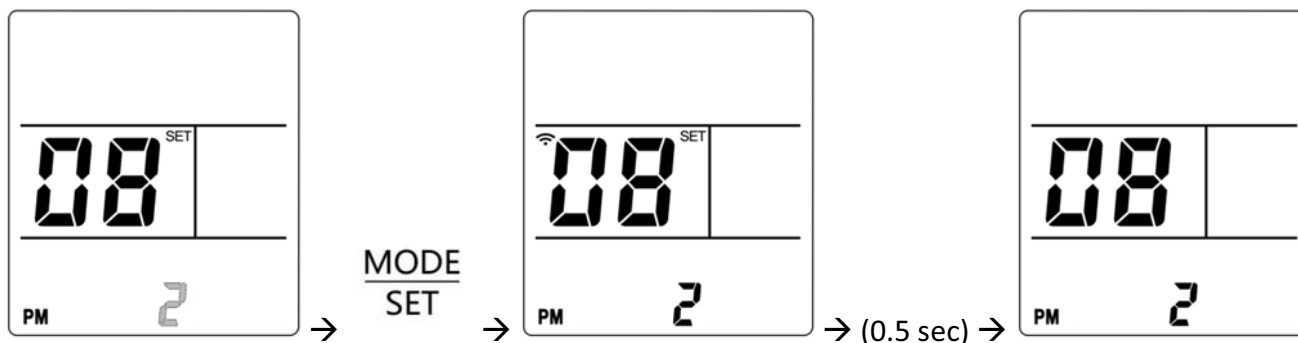

Press “ON/OFF” to go back to main screen:

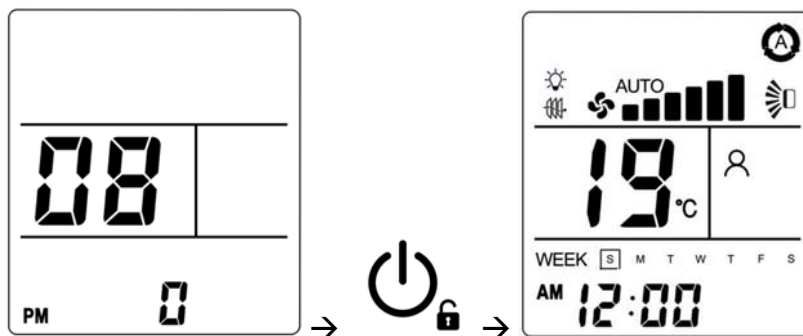

Par.	Parameter name	Min	Default	Max	Values
P00	Factory default reset	0	0	3	0 = No action 1 = Reset all remote control parameters to factory default value
P01	Software version	0	-	7	Software version of the remote controller
P05	Temperature scale	0	0	1	0 = °C (Celsius) 1 = °F (Fahrenheit)
P06	Transmission channel	0	0	3	0 = Channel #0 1 = Channel #1 2 = Channel #2 3 = Channel #3
P12	ECO mode power input limit	30	75	99	When ECO mode is selected, max electrical power input of the unit is limited to P12: 30 = 30% of Max Power Input 31 = 31% of Max Power Input ... 99 = 99% of Max Power Input

NOTE

Parameters not listed in the table are reserved and should not be changed. Changing the parameters not listed can cause the air conditioner to malfunction.

ADJUSTING THE AIR FLOW DIRECTION

EN VERTICAL

Hold the end of the flap and move it up and down to adjust the vertical air flow.

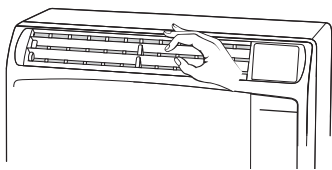

HORIZONTAL

The horizontal air flow can be adjusted by moving the vertical blades to the left or right, as indicated in the following figure.

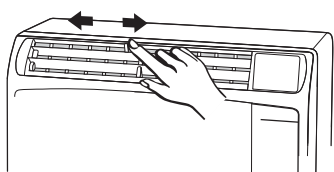

CAUTION

Set vertical blades to the front position during **COOLING/DRY** operation if humidity is high. If the vertical blades are set to the left-most or right-most position, condensation will form around the air outlet and drip off.

OPERATION WITHOUT THE REMOTE CONTROL UNIT

If necessary, the air conditioner can operate without a remote control:

1. WHEN THE AIR CONDITIONER IS OFF

If you want to turn on the air conditioner push the **OPERATION BUTTON** to select the **COOLING** mode:

NOTE

The air conditioner will start in **HIGH** fan speed. The temperature setting is **25°C**.

2. WHEN THE AIR CONDITIONER IS ON

If you want to turn off the air conditioner push the **OPERATION BUTTON** again.

NOTE

Power failure during operation.

In the event of power failure, the unit will stop. When the power is restored, the unit automatically restarts after 3 minutes. The operating settings are stored 1 minute after the last remote control signal received from the unit.

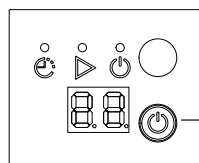

OPERATION BUTTON

CARE AND CLEANING



CAUTION

For safety, be sure to turn the air conditioner off and also to disconnect the power before cleaning.

OUTDOOR UNIT (CASING AND CONDENSING COIL)

- Some metal edges and the condenser fins are sharp and may cause injury if handled improperly; special care should be taken when you clean these parts.
- Periodically check the outdoor unit to see if the air outlet or air intake are clogged up with dirt or soot.
- The condenser and other components of the outdoor unit must be cleaned periodically. Consult your **DEALER** or **AFTER SALES SERVICE**.

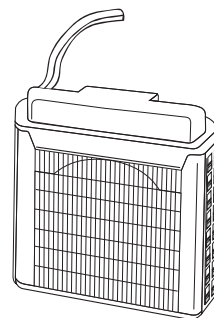

INDOOR UNIT

- Do not pour water on the unit to clean it. This will damage the internal components and cause an electric shock hazard.
- Never use solvents, or chemical agents when cleaning the indoor unit. Do not wipe the plastic casing using very hot water.

Casing and Grille

Clean the casing and grille of the indoor unit with a vacuum cleaner brush, or wipe them with a clean, soft cloth. If these parts are stained, use a clean cloth moistened with a mild liquid detergent. When cleaning the grille, be careful not to force the blades out of place.

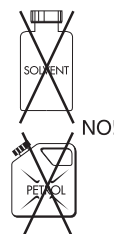
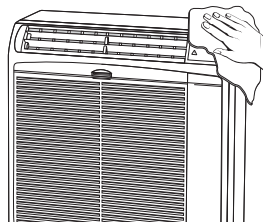

AIR FILTER

The air filter must be checked at least once every two weeks operation. Operation with a dirty filter always causes a lower efficiency of the air conditioner and severe product damage. The filter is located at the back of the intake grille in the front of the air-conditioner and shall be removed from the upper side of the unit.

HOW TO REMOVE THE FILTER

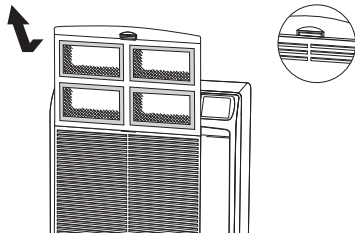

FILTER CLEANING

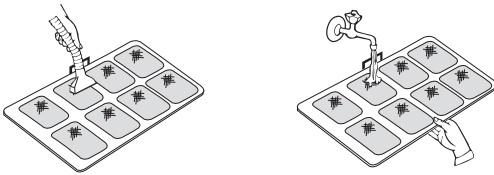

Use a vacuum cleaner to remove light dust. If there is sticky dust on the filter, wash the filter in lukewarm, soapy water, rinse it in clean water, and dry it.

TRANSPORT

Keep the air conditioner in the vertical position during transportation.

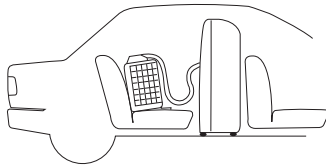

STORAGE

If you are not going to use the air-conditioner for a long period, clean the air filters, evacuate the condensate from the indoor unit through the drain hose at the unit back side. Do not disconnect the flexible tube, unless you are obliged to do it: in that case protect the open halves of the couplings, after disconnecting it and before handling the flexible hose and the outdoor unit; utilize the plastic plugs supplied as accessories, that must be tightened with a spanner. After handling, reconnect the flexible tube to the outdoor unit to avoid refrigerant leaks during the storage. Do not put heavy objects on the top of the unit, and protect it with a cloth or a plastic bag.

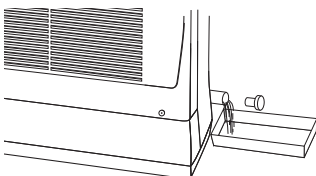

 CONDENSATE DRAIN PIPE

ACCESSORIES (SUPPLIED ON REQUEST)

OUTDOOR UNIT SUPPORT BRACKET KIT

EN

It is possible to buy a support bracket kit for the installation of outdoor unit.

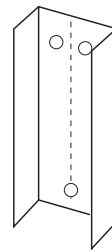
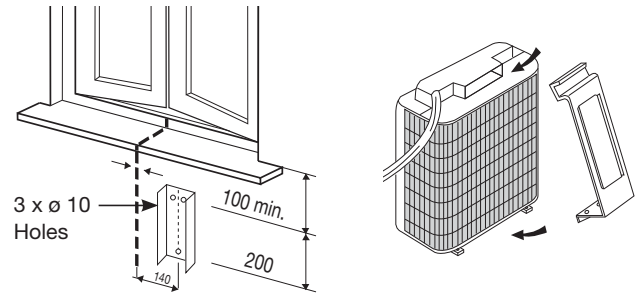

SUPPORT GUIDE

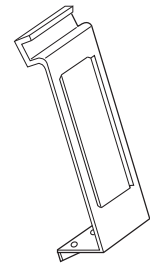

SUPPORT

TIPS FOR ENERGY SAVING

EN

DO NOT:

- Block the air intake and outlet of the unit. If they are obstructed, the unit will not work well, and may be damaged.
- Let direct sunlight into the room. Use sunshades, blind or curtain.

DO:

- Always try to keep the air filter clean. A clogged filter will impair the performance of the unit.
- To prevent conditioned air from escaping, keep windows, doors and any other openings closed.

TROUBLESHOOTING

- The use of portable telephones near the air-conditioner may cause disturbance to its normal operation and must be avoided. In case abnormal operation is noticed, (OPERATION lamp lights but outdoor unit will not run) to restore normal operation turn-off electric supply for 60 seconds at least, by disconnecting the main switch or the wall plug, then start again the air-conditioner.
- The blinking OPERATION lamp, together with the stop of the air conditioner for a short time are due to the exceeding condensate drainage. (see table "AUTO-DIAGNOSIS")

If the OPERATION lamp goes on blinking and the air conditioner definitely stops means that the condensate pump is not working or that the condensate drain pipe in the flexible connection pipe is obstructed; in this case contact the AFTER SALE SERVICE.

In case of emergency the air conditioner can work by draining the condensate from the back little pipe into a rather short container: extract the little pipe and remove the cap.

- If your air conditioner does not work properly, first check the following points before requesting service. If it still does not work properly, contact your dealer or service center.

Trouble: the air conditioner does not run at all.

Possible cause:

1. Power failure.
2. Leakage breaker tripped.
3. Line voltage is too low.
4. Operation button is OFF.
5. Batteries in remote control unit have run down.

Remedy:

1. Restore power.
2. Contact service center.
3. Consult your electrician or dealer.
4. Press the button again.
5. Replace batteries.

Trouble: Compressor runs but soon stops.

Possible cause:

1. Obstruction in front of condenser coil.

Remedy:

1. Remove obstruction.

Trouble: Poor cooling performance.

Possible cause:

1. Dirty or clogged air filter.
2. Heat source or many people in room.
3. Doors and/or windows are open.
4. Obstacle near air intake or air discharge port.
5. Thermostat is set too high.

Remedy:

1. Clean air filter to improve airflow.
2. Eliminate heat source if possible.
3. Shut them to keep the heat or cold out.
4. Remove it to ensure good airflow.
5. Set the temperature lower.

Trouble: Clicking sound is heard from the air conditioner.



Possible cause:

1. Any plastic parts may expand or shrink due to a sudden temperature change. In this event, a clicking sound may occur.

Remedy:

1. This is normal, and the sound will disappear when an even temperature is settled.

AUTO-DIAGNOSIS

N.	LED			POSSIBLE CAUSE	REMEDY
	TIMER	OPERATION	STANDBY		
					
-	✱	●	✱	Heating mode not available	Select an available mode
E1	✱	✱	✱	Communication error with HMI receiver PCB (WiFi model only)	Contact service centre
E2	○	✱	○	Condensate drainage error (float error)	Contact service centre
E3	●	●	✱	PFC error (over current, over voltage or PFC communication error)	Contact service centre
E4	✱	●	○	Internal fan malfunction	Contact service centre
E5	●	○	✱	Inverter PCB overtemperature (compressor module)	Contact service centre
E6	○	●	✱	Compressor overcurrent	Contact service centre
E7	○	✱	✱	Defective or disconnected indoor air sensor (RAT)	Contact service centre
E8	✱	✱	○	Defective or disconnected coil sensor (ICT)	Contact service centre
E9	○	○	✱	Defective or disconnected compressor discharge temperature sensor (CDT)	Contact service centre

○ = LED off ● = LED on ✱ = flashing LED

**INFORMATION FOR CORRECT DISPOSAL OF THE PRODUCT IN ACCORDANCE WITH THE EUROPEAN DIRECTIVE 2012/19/EU**

At the end of its working life this equipment must not be disposed of as an household waste. It must be taken to special local community waste collection centres or to a dealer providing this service. Disposing of an electrical and electronic equipment separately avoids possible negative effects on the environment and human health deriving from an inappropriate disposal and enables its components to be recovered and recycled to obtain significant savings in energy and resources. In order to underline the duty to dispose of this equipment separately, the product is marked with a crossed-out dustbin.

**INFORMATION FOR CORRECT DISPOSAL OF THE BATTERY IN ACCORDANCE WITH THE EUROPEAN DIRECTIVE 2006/66/EC AND MODIFICATIONS INTRODUCED BY DIRECTIVE 56/2013/EU**

Please replace battery when its electricity charge is used up: please do not eliminate this battery together with normal household waste. It must be taken to special local community waste collection centres or to a dealer providing this service. Disposing of a battery separately avoids possible negative effects on the environment and human health deriving from an inappropriate disposal and enables its components to be recovered and recycled to obtain significant savings in energy and resources. In order to underline the duty to dispose of this equipment separately, the battery is marked with a crossed-out dustbin.

REGULATION (EU) No. 517/2014 - F-GAS

The unit contains R32, a fluorinated greenhouse gas with a global warming potential (GWP) of 675. Do not release R32 into the atmosphere.

argoclima S.p.A.

Via Alfeno Varo, 35 - 25020 Alfianello - BS - Italy

Tel. +39 0331 755111 - Fax +39 0331 755501

www.argoclima.com



WiFi GUIDE **EN**

GUIDA ALLA WiFi **IT**

GUIDE WiFi **FR**

LEITFADEN ZU WiFi **DE**

GUÍA DE WiFi **ES**

GUIA DE WiFi **PT**

ULISSE **ECO**

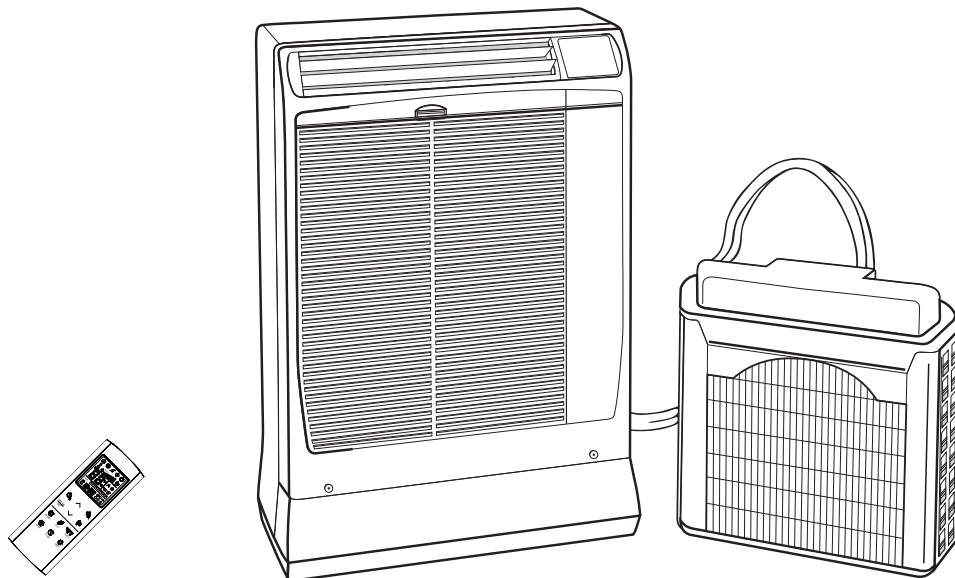

Room air conditioner with remote condenser

Condizionatore d'ambiente con condensatore remoto

Climatiseur avec condenseur a air exterieur

Klimagerät mit außengerät

Acondicionador de ambiente con condensador a distancia

Ar Condicionado com condensador remoto

CONTENTS

EN

WiFi configuration (first start-up)	2
Starting and using the Web APP	3
WiFi Network reset	5
Configuration problems	5

WiFi CONFIGURATION (FIRST START-UP)

1. Connect the unit to the main power supply.
2. Check that the WiFi STATUS LED (point at the bottom right of the display) flashes. If it does not flash, disconnect the power supply, wait for the display to turn off and reconnect the power supply again.

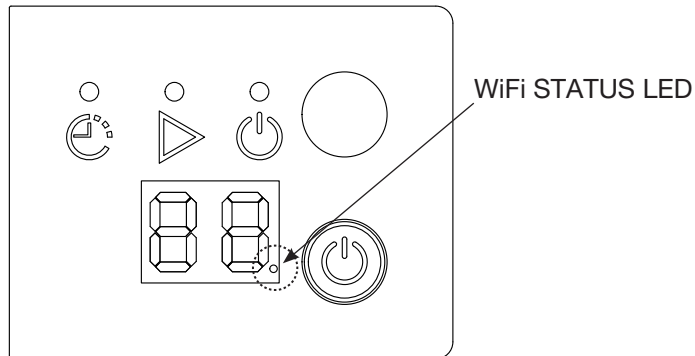

3. Within 5 minutes connect to the “UI_setup” WiFi network selecting it manually from the list of available WiFi networks or framing the QR code shown alongside.
4. If the phone reports an internet connection error, for example “no internet connection”, choose the option to keep the connection to WiFi “UI_setup”.
5. If the WiFi network connection process was successful, the WiFi STATUS LED starts blinking faster.



6. Within 10 minutes, using the same smartphone or other device that is connected to the “UI-setup” WiFi network, connect to the web page <http://192.168.4.1> or frame the QR code shown alongside.



7. The configuration screen shown alongside will appear. Select from the drop-down menu the WiFi network you want to connect to.
8. Enter the password of the selected WiFi network.
9. Press the **WiFi Connect** button to confirm the entered data and connect to the WiFi.

The screenshot shows a 'WiFi Setup' screen with the following elements: a title 'WiFi Setup', a 'WIFI SSID' dropdown menu showing 'MAV-WLAN3', a 'WIFI Password' field with 'micro' entered, and a 'WiFi Connect' button. An arrow points from step 9 to the 'WiFi Connect' button.

- 10. In the section APP account the default Username and Password will be displayed (generated automatically by the unit). Write down this information to access the APP in the future.
- 11. Press the **APP Connect** button. If the credentials are correct, the confirmation message “ACCOUNT CREATED OK” will appear.
- 12. Wait for the unit to connect to the WiFi network. If the connection is successful, the WiFi STATUS LED will stop flashing and it will stay on steady.



STARTING AND USING THE Web APP

When the unit is suitably configured and connected to the internet, it is possible to control and monitor it via a dedicated WEBAPP. To use these features, you must use the UserName and PassWord previously created during the configuration phase and have received confirmation of account creation (ACCOUNT CREATED OK). In this case you can proceed as follows:

- 1. Check that the unit is connected to WiFi (WiFi STATUS LED lit steady on the display).
- 2. Open the Web APP by connecting to the address <http://31.14.128.210/UI/WEBAPP/webapp.php?logo=Argo> or scan the QR code alongside.
NOTE: In order to access the WEBAPP, the phone or tablet must be connected to the Internet too.



- 3. The login screen shown alongside will appear: Enter your username and password and log in. It is recommended to check the “Remember me” box, so that you can access it more quickly the next times.

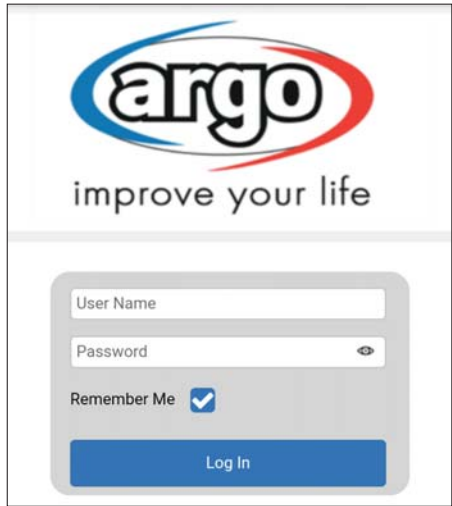

4. Once logged in, the following page will appear.

Use the APP as if it were the remote control of the unit. For using instructions of the remote control, refer to the user manual supplied with the unit or available on the official website.

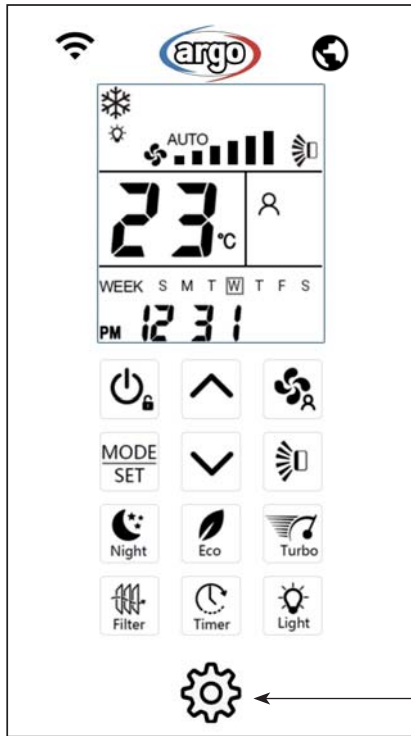

Click here to change the settings. The following screen will appear:

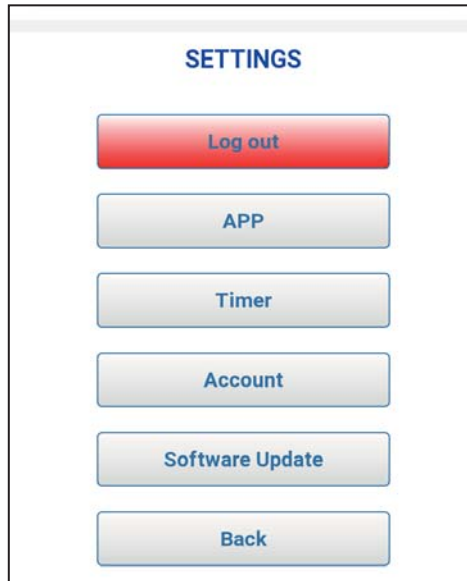

- Log out:** to log out and return to login
- APP:** to change APP settings: language, etc.
- Timer:** to set the time schedules
- Account:** to modify or remove the account
- Software Update:** to update the unit software
- Back:** to go back to the main screen

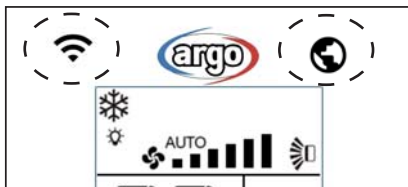

← MEANING OF Web App SYMBOLS

		APP and unit communicate with each other through the internet (WAN)
		APP and unit communicate with each other directly through the router (LAN)
		APP is connected to the internet server, but it does not communicate with the unit
		APP does not communicate with the unit and it does not have access to the internet server

5. In case of use from a smartphone or tablet, it is recommended to save the application in the device home, so that you can access it more quickly and get a more functional work screen. To do this, follow the next steps:

- **In case of iOS device:** Select the 'Add to Home screen' button; if it is not present, scroll down until it is displayed. The application icon will appear on the HOME screen to access the WEBAPP.

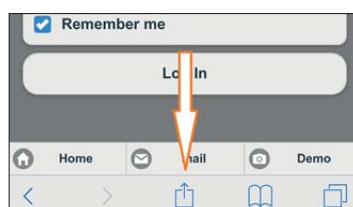

• In case of ANDROID device:

Press the symbol at the top of the screen, shown alongside

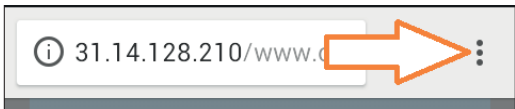

Select 'Add to Home Screen'

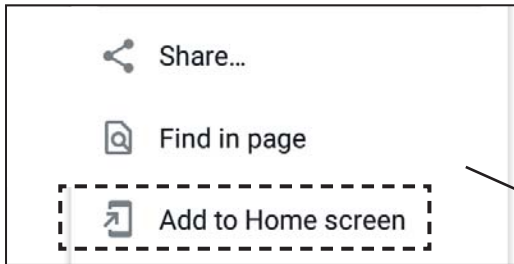

This screen will appear: digit a name

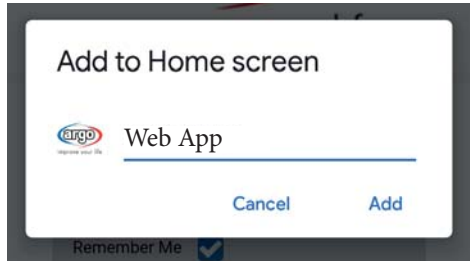

WiFi NETWORK RESET

To reset the access credentials to the WiFi network, for example to connect to a new network or to change the settings of the existing network, press the unit's operating button for 5 seconds. You will hear a "beep" and the WiFi STATUS LED will start flashing again.

Follow again the instructions of the section "WiFi CONFIGURATION"

CONFIGURATION PROBLEMS

ERROR MESSAGES: during the connection test, some error messages may appear. Possible messages are listed below:

USN or PSW ERROR!!: this message may indicate that the user name or password of the account are already used and therefore it is not possible to create an account with these credentials. You need to change your username and password and create a new account. To do this, contact the service centre by providing the technician the username and the password currently displayed on the configuration page.

NOWIFICONNECTION: this message indicates that it was not possible to connect to the selected WiFi network. Possible causes are:

1. Wrong password.
2. Temporary failure of the indicated WiFi.
3. Encryption type not supported. The supported encryption types are listed below:
Open, WEP, WPA_PSK, WPA2_PSK, WPA_WPA2_PSK
WPA2_Enterprise is not currently supported.

NOSERVERFOUND: it indicates that a connection with the server is not possible. Possible causes are:

1. Absence of the INTERNET connection for the WiFi indicated. There may be a problem with the ROUTER. Try switching it off and restarting it.
2. Temporary failure of the network. Try again in 30 minutes. If the problem persists, contact customer service by providing the technician with the data displayed on the configuration page.

argoclima s.p.a.

Via Alfeno Varo, 35 - 25020 Alfianello - BS - Italy

Tel. +39 0331 755111 - Fax +39 0331 755501

www.argoclima.com